



## Axial roof fan

# Tower-A

Air capacity – up to 2500 m<sup>3</sup>/h

### Use

- Exhaust ventilation systems installed in various premises.
- Roof mounting.
- For any types of roofs or vertical ventilation shafts.

### Design

- Steel casing and impeller with a special polymer atmospheric resistant coating.
- Horizontal air exhaust.
- The fan is equipped with a terminal block for connection to power mains.
- The fan is rated for continuous operation.
- A connecting plate with an intake opening is designed to facilitate mounting to the roof surface.

### Motor

- Two- or four-pole asynchronous motor with external rotor and axial impeller.
- Single-phase (E) motor modification.
- Equipped with ball bearings for longer service life.
- Overheating protection by built-in thermal switches with automatic restart.

### Overall dimensions

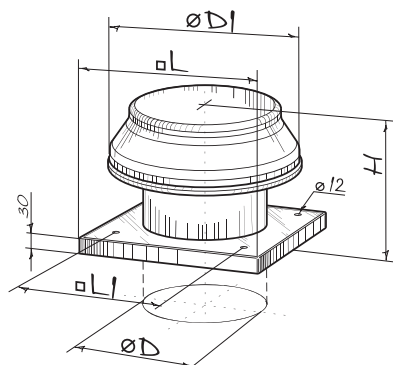

Type	Dimensions [mm]					Weight [kg]
	ØD	ØD1	H	L	L1	
Tower-A 200 2E	208	345	250	425	330	4.5
Tower-A 250 2E	262	405	280	425	330	7.0
Tower-A 250 4E	262	405	280	425	330	7.0
Tower-A 300 2E	314	555	340	585	450	10.5
Tower-A 300 4E	314	555	340	585	450	10.5
Tower-A 350 4E	364	555	350	655	535	12.0

### Speed control



- Smooth speed control with an external thyristor controller or step speed control with an external auto transformer (both available upon separate order).

### Mounting

- Roof mounting directly above a ventilation shaft or air duct.
- The fan is connected to the air duct with the intake flange that is fixed to the fan base.
- The fan base has holes for fixing bolts that attach the fan to a stable level surface or a roof frame.
- Roof frame and intake flange available on separate order.
- Power is supplied through an external terminal box.

ErP data	
Overall efficiency	η, (%)
Measurement category	MC
Efficiency category	EC
Efficiency grade	N
Variable speed drive	VSD
Power	[kW]
Current	[A]
Air flow	[m <sup>3</sup> /h]
Static pressure	[Pa]
Speed	[n/min <sup>-1</sup> ]
Specific ratio	SR

## Specifications

Parameters	Tower-A 200 2E*	Tower-A 250 2E*	Tower-A 250 4E*	Tower-A 300 2E 	Tower-A 300 4E*	Tower-A 350 4E 
Voltage [V / 50 Hz]	230	230	230	230	230	230
Power [W]	55	80	50	145	75	140
Current [A]	0.26	0.4	0.22	0.66	0.35	0.65
Maximum air capacity [m³/h]	860	1050	800	2230	1340	2500
RPM [min <sup>-1</sup> ]	2300	2400	1380	2300	1350	1380
Sound pressure level at 3 m distance [dBA]	50	60	55	60	58	62
Max. operating temperature [°C]	-30 +60	-30 +60	-30 +60	-30 +60	-30 +60	-30 +60
Ingress protection rating	IP X4	IP X4	IP X4	IP X4	IP X4	IP X4

\* Compliant to the ErP-regulation (EC) 327/2011, the power consumption at optimum efficiency is < 125W.

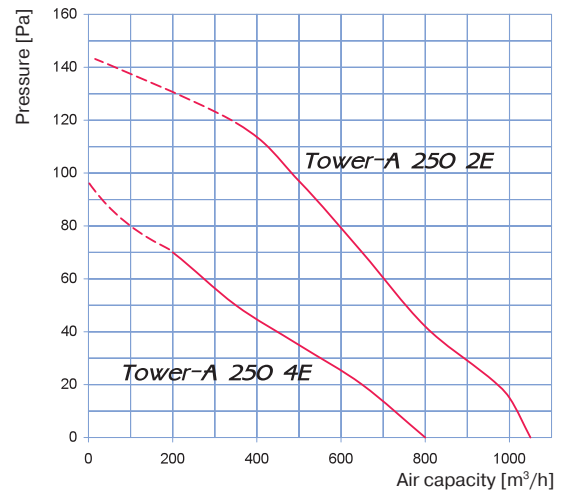
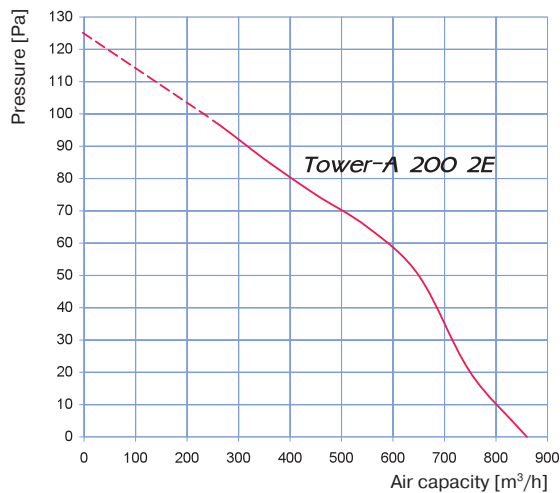

Sound-power level	Octave-frequency band [Hz]								
	Gen	63	125	250	500	1000	2000	4000	8000
L <sub>WA</sub> to inlet, [dBA]	66	58	58	57	58	57	53	52	46
L <sub>WA</sub> to environment, [dBA]	65	57	57	58	60	55	57	53	47

Sound-power level	Octave-frequency band [Hz]								
	Gen	63	125	250	500	1000	2000	4000	8000
<b>Tower-A 250 2E</b>									
L <sub>WA</sub> to inlet, [dBA]	76	69	66	69	71	68	68	61	56
L <sub>WA</sub> to environment, [dBA]	78	65	70	69	71	69	64	62	60
<b>Tower-A 250 4E</b>									
L <sub>WA</sub> to inlet, [dBA]	59	50	51	53	55	53	51	45	43
L <sub>WA</sub> to environment, [dBA]	60	51	52	54	55	54	51	45	42

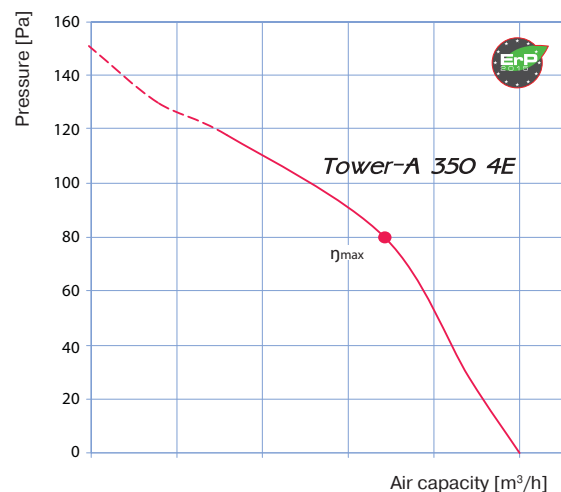
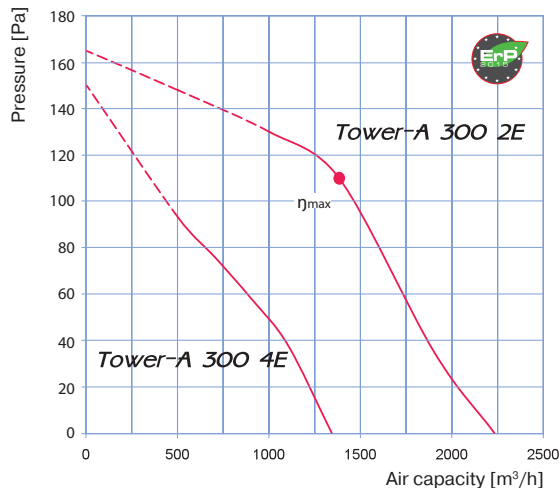

Sound-power level	Octave-frequency band [Hz]								
	Gen	63	125	250	500	1000	2000	4000	8000
<b>Tower-A 300 2E</b>									
L <sub>WA</sub> to inlet, [dBA]	79	68	71	73	72	71	69	64	59
L <sub>WA</sub> to environment, [dBA]	78	68	72	72	74	72	70	64	61

Sound-power level	Octave-frequency band [Hz]								
	Gen	63	125	250	500	1000	2000	4000	8000
<b>Tower-A 300 4E</b>									
L <sub>WA</sub> to inlet, [dBA]	66	55	57	58	58	57	53	51	48
L <sub>WA</sub> to environment, [dBA]	65	56	56	57	57	57	55	51	49

<b>Tower-A 300 2E</b>										
η <sub>v</sub> (%)	MC	EC	N	VSD	[kW]	[A]	[m³/h]	[Pa]	[RPM]	SR
30.5	A	Static	30.5	No	0.141	0.64	1380	110	2350	1

Sound-power level	Octave-frequency band [Hz]								
	Gen	63	125	250	500	1000	2000	4000	8000
L <sub>WA</sub> to inlet, [dBA]	70	61	62	61	65	61	58	56	53
L <sub>WA</sub> to environment, [dBA]	68	61	63	63	62	60	60	56	52

<b>Tower-A 350 4E</b>										
η <sub>v</sub> (%)	MC	EC	N	VSD	[kW]	[A]	[m³/h]	[Pa]	[RPM]	SR
29.9	A	Static	41.8	No	0.130	0.6	1717	80	1375	1