



Axial wall fan

Axis-Q

Air capacity – up to 12200 m³/h



■ Use

- Supply and exhaust ventilation systems installed in various premises.
- Ideal solution for boosting large air volumes at low aerodynamic resistance in the ventilation system.
- Refrigerating technologies for cooling of compressor condensing units.
- Direct air exhaust.
- For positive pressure ventilation in fire-fighting systems.

■ Design

- Steel casing and impeller with a special polymer atmospheric resistant coating.
- Casing is equipped with a square mounting plate and a round flange to facilitate wall mounting.
- The fan is equipped with a terminal box for connection to power mains.

■ Motor

- Two- or four-pole asynchronous motor with external rotor and axial impeller.
- Single-phase (**E**) or three-phase (**D**) motor modifications.
- Equipped with ball bearings for longer service life.
- Integrated overheating protection with automatic restart.

■ Speed control

- Smooth speed control with an external thyristor controller or step speed control with an external auto transformer (both available upon separate order).

■ Mounting

- Wall surface mounting with a square connecting frame.
- Any mounting position with respect to air flow direction in the system.
- Power is supplied through an external terminal box.

ErP data	
Overall efficiency	η , (%)
Measurement category	MC
Efficiency category	EC
Efficiency grade	N
Variable speed drive	VSD
Power	[kW]
Current	[A]
Air flow	[m ³ /h]
Static pressure	[Pa]
Speed	[n/min ⁻¹]
Specific ratio	SR

Overall dimensions

Type	Dimensions [mm]					Weight [kg]
	$\varnothing D$	$\varnothing d$	B	B1	L	
Axis-Q 200 2E	210	7	312	260	145	3.95
Axis-Q 250 2E	260	7	370	320	155	4.17
Axis-Q 250 4E	260	7	370	320	155	4.06
Axis-Q 300 2E	326	9	430	380	195	5.27
Axis-Q 300 4E	326	9	430	380	195	5.11
Axis-Q 350 4E	388	9	485	435	200	7.05
Axis-Q 400 4E	417	9	540	490	240	8.80
Axis-Q 450 4E	465	11	576	535	250	10.50
Axis-Q 500 4E	520	11	655	615	260	14.15
Axis-Q 550 4E	570	11	725	675	280	16.50
Axis-Q 630 4E	650	11	800	710	295	22.55
Axis-Q 250 2D	260	7	370	320	155	4.17
Axis-Q 250 4D	260	7	370	320	155	4.06
Axis-Q 300 2D	326	9	430	380	155	5.27
Axis-Q 300 4D	326	9	430	380	155	5.11
Axis-Q 350 4D	388	9	485	435	200	7.05
Axis-Q 400 4D	417	9	540	490	240	8.80
Axis-Q 450 4D	465	11	576	535	250	10.50
Axis-Q 500 4D	520	11	655	615	260	14.2
Axis-Q 550 4D	580	11	725	675	260	16.6
Axis-Q 630 4D	650	11	800	710	295	22.6
Axis-Q 630 6E	650	11	800	710	295	22.6

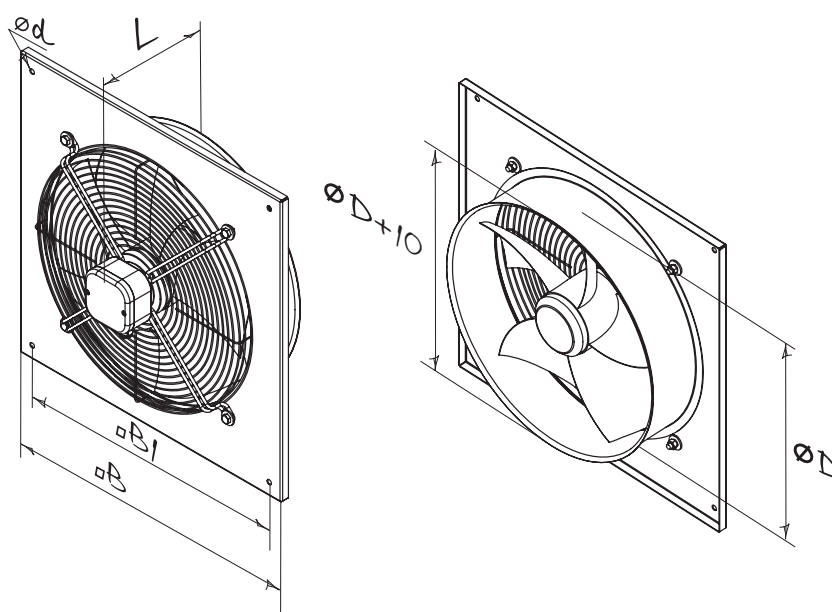

Specifications

Parameters	Axis-Q 200 2E*	Axis-Q 250 2E*	Axis-Q 250 4E*	Axis-Q 300 2E 	Axis-Q 300 4E*
Voltage [V / 50 Hz]	230	230	230	230	230
Power [W]	55	80	50	145	75
Current [A]	0.26	0.4	0.22	0.66	0.35
Maximum air capacity [m ³ /h]	860	1050	800	2230	1340
RPM [min ⁻¹]	2300	2400	1380	2300	1350
Sound pressure level at 3 m distance [dBA]	50	60	55	60	58
Max. operating temperature [°C]	-30 +60	-30 +60	-30 +60	-30 +60	-30 +60
Ingress protection rating	IP24	IP24	IP24	IP24	IP24

* Compliant to the ErP-regulation (EC) 327/2011, the power consumption at optimum efficiency is < 125W.

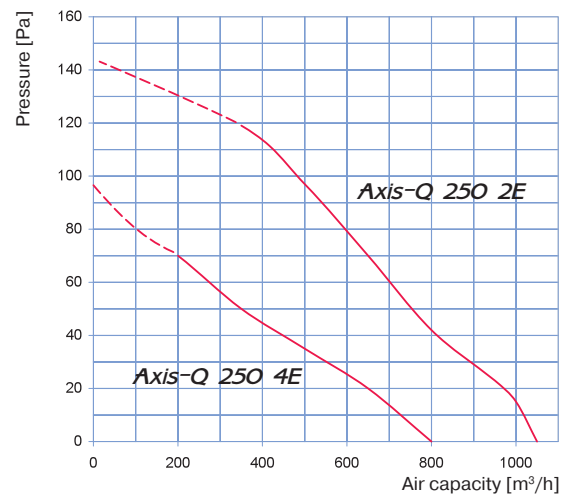
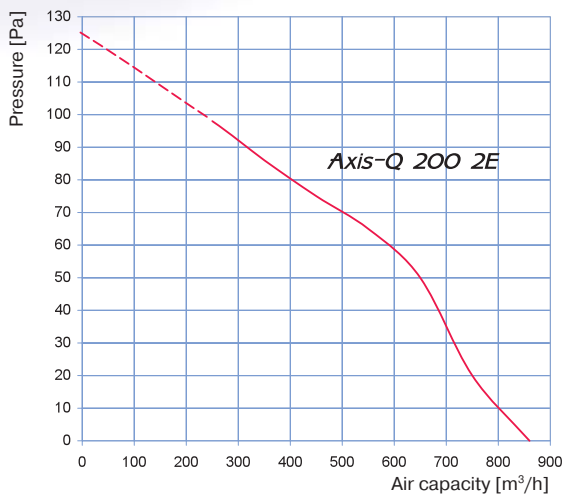





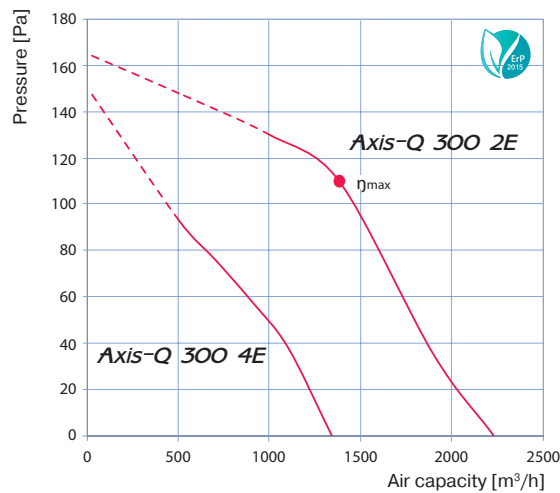

Sound-power level	Octave-frequency band [Hz]								
	Gen	63	125	250	500	1000	2000	4000	8000
L _{WA} to environment, [dBA]	65	56	58	58	57	59	55	51	45

Sound-power level	Octave-frequency band [Hz]								
	Gen	63	125	250	500	1000	2000	4000	8000
Axis-Q 250 2E									
L _{WA} to environment, [dBA]	76	68	66	68	70	68	68	63	58
Axis-Q 250 4E									
L _{WA} to environment, [dBA]	60	52	50	52	53	52	52	44	43



Sound-power level	Octave-frequency band [Hz]									
	Gen	63	125	250	500	1000	2000	4000	8000	
Axis-Q 300 2E										
L _{WA} to environment, [dBA]	78	72	72	70	72	70	69	63	63	
Axis-Q 300 4E										
L _{WA} to environment, [dBA]	67	58	57	59	57	58	53	52	49	
Axis-Q 300 2E										
η _s , (%)	MC	EC	N	VSD	[kW]	[A]	[m ³ /h]	[Pa]	[RPM]	SR
30.5	A	Static	42.2	No	0.141	0.64	1380	110	2350	1

Specifications

Parameters	Axis-Q 350 4E 	Axis-Q 400 4E 	Axis-Q 450 4E 	Axis-Q 500 4E 	Axis-Q 550 4E 	Axis-Q 630 4E 
Voltage [V / 50 Hz]	230	230	230	230	230	230
Power [W]	140	180	250	420	550	750
Current [A]	0.65	0.82	1.2	1.95	2.55	3.5
Maximum air capacity [m ³ /h]	2500	3580	4680	7060	8800	11900
RPM [min ⁻¹]	1380	1380	1350	1300	1300	1360
Sound pressure level at 3 m distance [dBA]	62	63	64	69	70	75
Max. operating temperature [°C]	-30 +60	-30 +60	-30 +60	-30 +60	-30 +60	-30 +60
Ingress protection rating	IP24	IP24	IP24	IP24	IP24	IP24

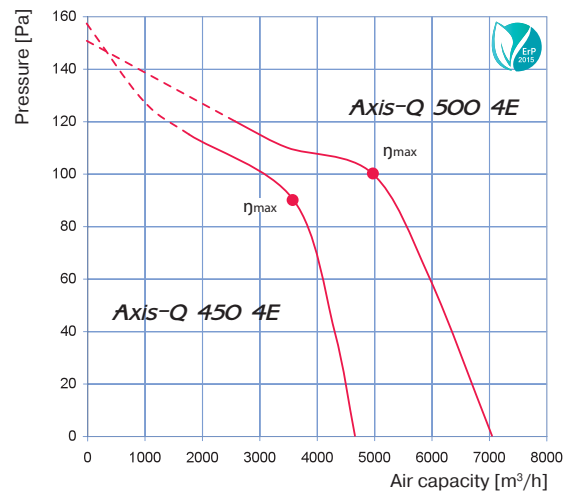
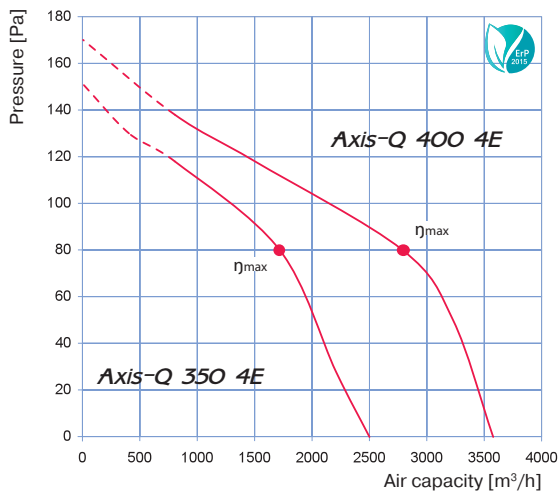

Sound-power level	Octave-frequency band [Hz]							
	Gen	63	125	250	500	1000	2000	4000

Axis-Q 350 4E

L _{WA} to environment, [dBA]	70	61	62	64	63	63	58	56	52
---------------------------------------	----	----	----	----	----	----	----	----	----

Axis-Q 400 4E

L _{WA} to environment, [dBA]	75	66	68	66	69	67	65	61	56
---------------------------------------	----	----	----	----	----	----	----	----	----

Axis-Q 350 4E

η _v (%)	MC	EC	N	VSD	[kW]	[A]	[m ³ /h]	[Pa]	[RPM]	SR
--------------------	----	----	---	-----	------	-----	---------------------	------	-------	----

29.9	A	Static	41.8	No	0.130	0.6	1717	80	1375	1
------	---	--------	------	----	-------	-----	------	----	------	---

Axis-Q 400 4E

η _v (%)	MC	EC	N	VSD	[kW]	[A]	[m ³ /h]	[Pa]	[RPM]	SR
--------------------	----	----	---	-----	------	-----	---------------------	------	-------	----

33.8	A	Static	44.8	No	0.187	0.86	2787	80	1355	1
------	---	--------	------	----	-------	------	------	----	------	---

Sound-power level	Octave-frequency band [Hz]							
	Gen	63	125	250	500	1000	2000	4000

Axis-Q 450 4E

L _{WA} to environment, [dBA]	77	69	70	73	73	71	67	67	61
---------------------------------------	----	----	----	----	----	----	----	----	----

Axis-Q 500 4E

L _{WA} to environment, [dBA]	80	71	73	72	74	73	70	67	63
---------------------------------------	----	----	----	----	----	----	----	----	----

Axis-Q 450 4E

η _v (%)	MC	EC	N	VSD	[kW]	[A]	[m ³ /h]	[Pa]	[RPM]	SR
--------------------	----	----	---	-----	------	-----	---------------------	------	-------	----

32.0	A	Static	41.8	No	0.288	1.31	3610	90	1270	1
------	---	--------	------	----	-------	------	------	----	------	---

Axis-Q 500 4E

η _v (%)	MC	EC	N	VSD	[kW]	[A]	[m ³ /h]	[Pa]	[RPM]	SR
--------------------	----	----	---	-----	------	-----	---------------------	------	-------	----

32.1	A	Static	40.7	No	0.440	2.01	4987	100	1285	1
------	---	--------	------	----	-------	------	------	-----	------	---

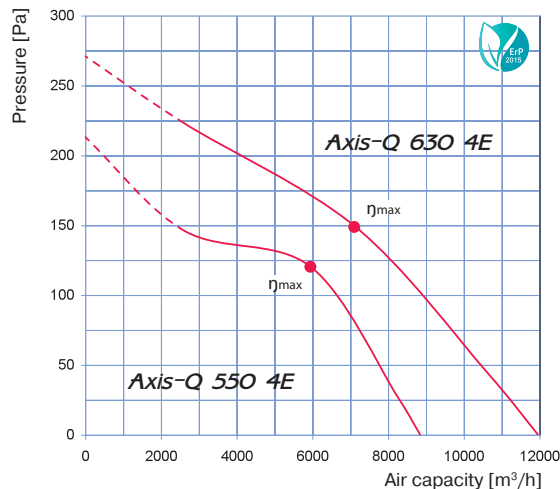

Sound-power level	Octave-frequency band [Hz]							
	Gen	63	125	250	500	1000	2000	4000

Axis-Q 550 4E

L _{WA} to environment, [dBA]	83	73	75	73	75	74	72	66	63
---------------------------------------	----	----	----	----	----	----	----	----	----

Axis-Q 630 4E

L _{WA} to environment, [dBA]	77	71	73	72	73	71	70	63	59
---------------------------------------	----	----	----	----	----	----	----	----	----

Axis-Q 550 4E

η _v (%)	MC	EC	N	VSD	[kW]	[A]	[m ³ /h]	[Pa]	[RPM]	SR
--------------------	----	----	---	-----	------	-----	---------------------	------	-------	----



34.7	A	Static	42.6	No	0.581	2.64	5919	120	1240	1
------	---	--------	------	----	-------	------	------	-----	------	---

Axis-Q 630 4E

η _v (%)	MC	EC	N	VSD	[kW]	[A]	[m ³ /h]	[Pa]	[RPM]	SR
--------------------	----	----	---	-----	------	-----	---------------------	------	-------	----

37.5	A	Static	44.4	No	0.800	3.76	7095	149	1290	1
------	---	--------	------	----	-------	------	------	-----	------	---

Specifications

Parameters	Axis-Q 250 2D*	Axis-Q 250 4D*	Axis-Q 300 2D 	Axis-Q 300 4D*	Axis-Q 350 4D 	Axis-Q 400 4D 
Voltage [V / 50 Hz]	400	400	400	400	400	400
Power [W]	80	60	145	75	140	180
Current [A]	0.22	0.17	0.25	0.22	0.38	0.47
Maximum air capacity [m ³ /h]	1060	850	2310	1310	2520	3740
RPM [min ⁻¹]	2600	1400	2350	1380	1380	1380
Sound pressure level at 3 m distance [dBA]	60	55	60	58	62	64
Max. operating temperature [°C]	-30 +60	-30 +60	-30 +60	-30 +60	-30 +60	-30 +60
Ingress protection rating	IP24	IP24	IP24	IP24	IP24	IP24

* Compliant to the ErP-regulation (EC) 327/2011, the power consumption at optimum efficiency is < 125W.

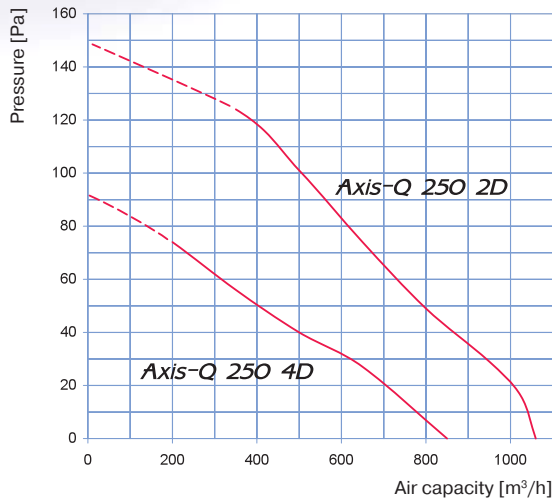

Sound-power level	Octave-frequency band [Hz]								
	Gen	63	125	250	500	1000	2000	4000	8000
Axis-Q 250 2D									
L _{WA} to environment, [dBA]	77	67	68	70	69	68	66	60	57
Axis-Q 250 4D									
L _{WA} to environment, [dBA]	60	49	50	53	54	53	52	45	42

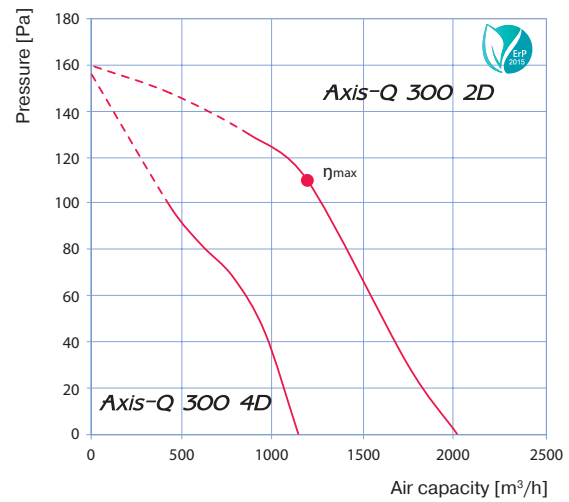



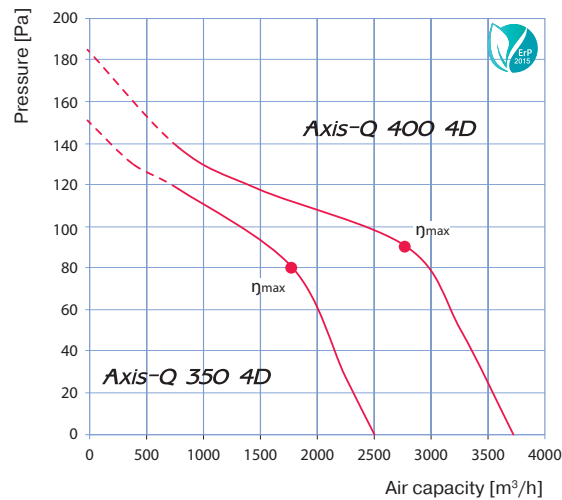

Sound-power level	Octave-frequency band [Hz]									
	Gen	63	125	250	500	1000	2000	4000	8000	
Axis-Q 300 2D										
L _{WA} to environment, [dBA]	80	72	71	71	74	70	69	65	63	
Axis-Q 300 4D										
L _{WA} to environment, [dBA]	63	58	55	58	56	58	57	52	48	
Axis-Q 300 2D										
η _e (%)	MC	EC	N	VSD	[kW]	[A]	[m ³ /h]	[Pa]	[RPM]	SR
30.3	A	Static	42	No	0.141	0.25	1367	110	2350	1



Sound-power level	Octave-frequency band [Hz]									
	Gen	63	125	250	500	1000	2000	4000	8000	
Axis-Q 350 4D										
L _{WA} to environment, [dBA]	72	62	61	64	64	61	61	56	54	
Axis-Q 400 4D										
L _{WA} to environment, [dBA]	75	65	66	69	66	67	64	60	55	
Axis-Q 350 4D										
η _e (%)	MC	EC	N	VSD	[kW]	[A]	[m ³ /h]	[Pa]	[RPM]	SR
31.7	A	Static	43.7	No	0.129	0.37	1802	80	1400	1
Axis-Q 400 4D										
η _e (%)	MC	EC	N	VSD	[kW]	[A]	[m ³ /h]	[Pa]	[RPM]	SR
34.3	A	Static	44.9	No	0.209	0.47	2807	90	1365	1

Specifications

Parameters	Axis-Q 450 4D 	Axis-Q 500 4D 	Axis-Q 550 4D 	Axis-Q 630 4D 	Axis-Q 630 6E 
Voltage [V / 50 Hz]	400	3 ~ 400	3 ~ 400	3 ~ 400	1 ~ 230
Power [W]	250	450	750	800	540
Current [A]	0.6	0.9	1.5	1.6	2.4
Maximum air capacity [m ³ /h]	5280	6570	9700	12200	10900
RPM [min ⁻¹]	1360	1300	1350	1320	850
Sound pressure level at 3 m distance [dBA]	65	72	73	78	72
Max. operating temperature [°C]	-30 +60	-30 +60	-30 +60	-30 +60	-30 +60
Ingress protection rating	IP24	IP24	IP24	IP24	IP24

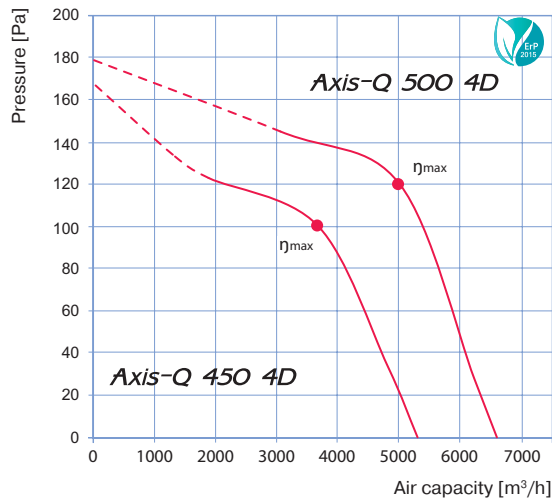

Sound-power level	Octave-frequency band [Hz]									
	Gen	63	125	250	500	1000	2000	4000	8000	
Axis-Q 450 4D										
L _{WA} to environment, [dBA]	76	65	68	69	69	70	64	60	57	
Axis-Q 500 4D										
L _{WA} to environment, [dBA]	82	73	71	75	78	76	71	65	61	
Axis-Q 450 4D										
η _v (%)	MC	EC	N	VSD	[kW]	[A]	[m ³ /h]	[Pa]	[RPM]	SR
35.1	A	Static	44.8	No	0.296	0.59	3659	100	1310	1
Axis-Q 500 4D										
η _v (%)	MC	EC	N	VSD	[kW]	[A]	[m ³ /h]	[Pa]	[RPM]	SR
35.5	A	Static	43.9	No	0.478	0.9	4988	120	1305	1

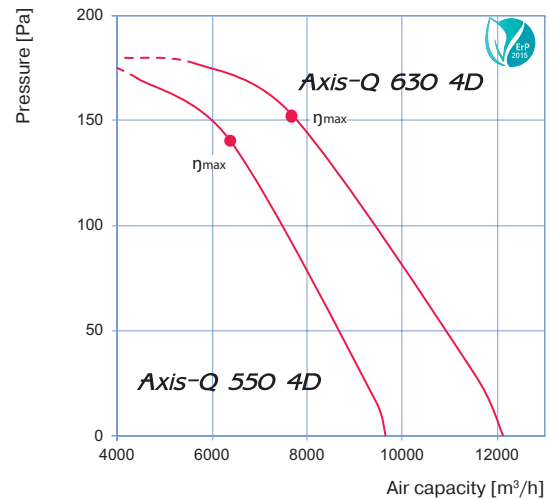

Sound-power level	Octave-frequency band [Hz]									
	Gen	63	125	250	500	1000	2000	4000	8000	
Axis-Q 550 4D										
L _{WA} to environment, [dBA]	84	75	79	72	76	71	77	69	68	
Axis-Q 630 4D										
L _{WA} to environment, [dBA]	78	75	69	70	74	74	69	65	64	
Axis-Q 550 4D										
η _v (%)	MC	EC	N	VSD	[kW]	[A]	[m ³ /h]	[Pa]	[RPM]	SR
38.8	A	Static	46.3	No	0.656	1.27	6400	140	1175	1
Axis-Q 630 4D										
η _v (%)	MC	EC	N	VSD	[kW]	[A]	[m ³ /h]	[Pa]	[RPM]	SR
41.2	A	Static	48.1	No	0.810	1.61	7743	152	1290	1

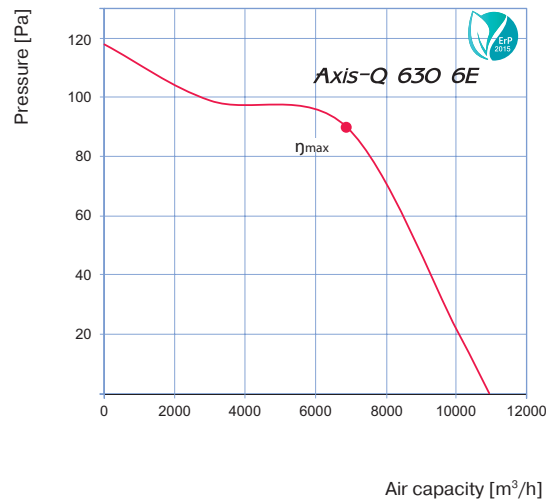

Sound-power level	Octave-frequency band [Hz]									
	Gen	63	125	250	500	1000	2000	4000	8000	
L _{WA} to environment, [dBA]	75	51	56	61	65	67	66	60	54	
Axis-Q 630 6E										
η _v (%)	MC	EC	N	VSD	[kW]	[A]	[m ³ /h]	[Pa]	[RPM]	SR
35	A	Static	43.3	No	0.500	2.55	6857	90	915	1